

## CHRONOVOLTAMMETRIC DETERMINATION OF OXYGEN FLUX DENSITY IN THE SOIL

M.A. Malicki, A. Bieganowski

Institute of Agrophysics, Polish Academy of Sciences, Doświadczalna 4, P.O. Box 201, 20-290 Lublin 27, Poland  
E-mail: mmal@demeter.ipan.lublin.pl

Accepted April 23, 1999

**A b s t r a c t.** A chronovoltammetric method for the determination of oxygen flux density (*OFD*) in the soil is proposed. The method is based on the current-potential relationship recorded on a platinum indicator electrode placed in the soil. The Pt electrode is polarized with electrical potential linearly decreasing from 0 V down to the level at the beginning of water electrolysis (about -0.7 V). Electrical current flowing across the electrode due to the electrode reduction processes of molecular oxygen is recorded. Mean magnitude of this current is the base for the calculation of the *OFD* in the soil. The results obtained were compared with oxygen diffusion rate (*ODR*) data read with the application of the amperometric method of Lemon and Erickson, where reduction current is read at the Pt cathode potential fixed at a level at random chosen from -650 to 400 mV interval. The results obtained using both methods showed a distinct correlation. At the same time the chronovoltammetric *OFD* data were less scattered than the amperometric *ODR* ones.

**K e y w o r d s:** oxygen diffusion rate determination, *ODR* of soil, soil aeration, oxygen flux density

### QUANTITIES AND SYMBOLS

$a$  - a constant equal to  $\frac{M_o}{nFS} (g C^{-1} m^{-2})$

**Amperometry** - an electrochemical method of determination of an electroactive substance concentration based on the measurement of electrical current across an indicator electrode under constant potential.

**Voltammetry** - an electrochemical method based on the measurement of electrical current across an indicator electrode under electrical potential changing in time.

**Chronovoltammetry** - voltammetry with the potential changing in time linearly.

$F$  - Faraday constant, equal to 96487 (C mol<sup>-1</sup>)

$J$  - electrical current resulting from electrode processes occurring at an indicator electrode|solution interface (A)

$J(U_{fix})$  - reduction current (A) at a fixed potential  $U = U_{fix}$  (V)

$J(U)$  - reduction current (A) at an optional potential  $U = U(t)$  (V)

$k$  - gram-equivalent (g C<sup>-1</sup>)

$m$  - mass (g)

$M_o$  - molar mass, for the oxygen equal to 32 (g mol<sup>-1</sup>)

$n$  - number of electrons involved in the reduction of a single molecule, for the oxygen equal to 4

*ODR* - oxygen diffusion rate (g cm<sup>-2</sup> s<sup>-1</sup>)

*OFD* - oxygen flux density (g cm<sup>-2</sup> s<sup>-1</sup>)

$Q$  - electrical charge (C)

$S$  - surface (m<sup>2</sup>)

SCE - saturated calomel electrode

$t$  - time (s)

$t_1$  - point in time at which the potential increase begins (s)

$t_2$  - instant the potential reaches a chosen magnitude (s)

$\theta$  - water content (cm<sup>3</sup> cm<sup>-3</sup>)

$\theta_1$  - threshold water content (cm<sup>3</sup> cm<sup>-3</sup>)

$U$  - electrical potential polarizing the indicator electrode (V). All the potentials mentioned

in this paper are referred to that of the saturated calomel reference electrode.

$U_e$  - electrical potential of electrolysis of water. For Pt, as referred to SCE, equal to about  $-0.7$  (V)

$U_{fix}$  - a fixed level electrical potential (expressed with regard to SCE) polarizing an indicator electrode (V). For Pt commonly set within the range of  $-0.400 \div -0.650$  (V)

$\nu$  - velocity cathode potential increase ( $\text{mV s}^{-1}$ )

var - variance defined here as  $(N-1)^{-1} \Sigma(ODR_i^* - ODR_i)^2$ , where  $ODR_i^*$  is the value converted from *OFD*.

### INTRODUCTION

The only sensors which can be integrated in the contemporary data acquisition systems must be read electrically. Oxygen diffusion rate (*ODR*) in the soil can be estimated electrically using an electrochemical amperometric method proposed by Lemon and Erickson [9,10]. The method has been adapted from polarography with a Pt cathode as the indicator electrode and a large-size saturated calomel electrode as the anode. The method is based on the oxygen reduction current,  $J$ , measured at a given *ODR*, flowing across the Pt cathode under a fixed potential,  $U_{fix}$  at random chosen within the range of  $-0.800 \div -0.480$  V [2].

The need to fix the potential of the cathode,  $U_{fix}$ , results from the lack of the polarographic plateau of the  $J(U)$  relation. Moreover, dependent on the soil acidity, the potential of water electrolysis,  $U_e$ , (that one at which the inflection of the  $J(U)$  relation appears) may be close to or the same as  $U_{fix}$  [2,13].

This makes the Lemon and Ericson's method troublesome because random setting of the cathode potential makes data obtained by different researchers not comparable.

The increasing importance of the soil aeration problem [6,7] combined with easy application of a microprocessor to record the whole current-voltage  $J(U)$  curve instead of a single pair  $J, U_{fix}$  (as it is in the case of the Lemon and Erickson's method) turned interest

back to electrochemical methods for the determination of *ODR* [11]. When the chronovoltametric curve is recorded over the cathode potential range in which oxygen reduction dominates, the problem of the cathode potential setting becomes immaterial. It is so, because having the curve recorded once, one can easily locate the  $J(U)$  inflection potential (equal to  $U_e$ ) then choose  $U_{fix}$  always less than  $U_e$ . Moreover, averaging the  $J(U)$  over the potential range in which oxygen reduction dominates, may lead to more accurate data of the oxygen flux in the soil.

### Background

The principle of the amperometric measurement of *ODR* according to Lemon and Erickson is illustrated in Fig. 1. When the key, K, is in the "on" position a 650 mV constant voltage source negatively polarizes the Pt cathode. The electrodes-soil system undergoes spatial polarization; electrolyte (the soil water) cations present in the soil cover the Pt cathode without discharge. After  $5 \div 20$  min [2] an inner, opposite electrical field develops which

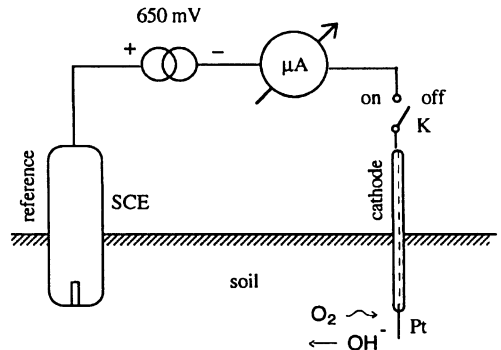

Fig. 1. Principle of the amperometric measurement of *ODR* in the soil according to Lemon and Erickson. Molecular oxygen is exhausted from the soil solution in the vicinity of the Pt cathode with the rate limited by its diffusive inflow. The role of the annihilator of oxygen is played by the electrode processes of oxygen reduction occurring on the Pt cathode (see text), when polarized with a fixed electrical potential of  $-650$  mV (as referred to SCE). The reduction current is read by the microammeter,  $\mu\text{A}$ . SCE is the electrode complementing the current circuit. The marked reagents concern neutral or alkaline environment.

compensates for the applied one. After steady state is established the magnitude of the resultant electrical field is close to zero. The molecular oxygen, if present in the soil water, depolarizes the cathode causing respective flow of a related electrical current. This oxygen reduction current,  $J$ , (read by a microammeter) is the base for the *ODR* calculation in the soil.

Absolute potential of the SCE (at 10°C) is +250 mV. Therefore (neglecting a parasite voltage drops across the 650 mV voltage source, the SCE, the soil and the microammeter) the absolute voltage developed across the Pt|soil interface is -400 mV. This voltage is too low to cause electrolysis of water. Its magnitude is, however, sufficient to develop an electrode process of reduction of some components of the soil solution, mainly molecules of the dissolved oxygen.

It is commonly considered that the most probable among the proposed [1,3] electrode processes of the molecular oxygen reduction on the platinum indicator electrode placed in an aerated water solution are the ones shown below:

- acid medium:

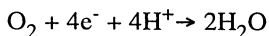

- alkaline or neutral medium:

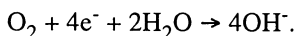

In general terms, if the Pt cathode polarizing potential is less than 0 and greater than  $U_e$  then the electrical current due to the oxygen reduction predominates and the current due to simultaneous reduction of components other than the molecular oxygen is negligible.

Electrical current related to the oxygen reduction is directly proportional to *ODR*, therefore:

$$\text{ODR} = \frac{J}{S} k. \tag{1}$$

Note, that the electrically inert molecules of oxygen do not migrate due to the applied electrical field. The inflow of the molecular

oxygen towards the cathode is developed by the gradient of the oxygen concentration and is purely diffusive.

If the cathode depletes molecular oxygen faster than it can be supplemented by the diffusive inflow from the surroundings then the oxygen diffusion rate is not affected by the cathode polarizing potential. However, it is limited by the oxygen diffusivity of the soil. Then *ODR* can be defined as the density of diffusive inflow of the molecular oxygen towards the cathode. The related reduction current,  $J$ , is expected to be independent of the cathode polarizing potential within -0.7 ÷ -0.2 V interval and the respective oxygen reduction current-voltage curve,  $J(U)$ , is expected to be flat. Figure 2 illustrates an idealized chronovoltammetric curve of the molecular oxygen reduction at a platinum cathode. The presence of the  $J(U)$  plateau indicates that within the cathode potential -0.70 ÷ -0.200 V the rate of oxygen diffusion is the only factor limiting the related electrical current,  $J$ .

In practice, however, the amperometric method of the *ODR* determination according to Lemon and Erickson appeared to have faults causing scientists to loose interest in its

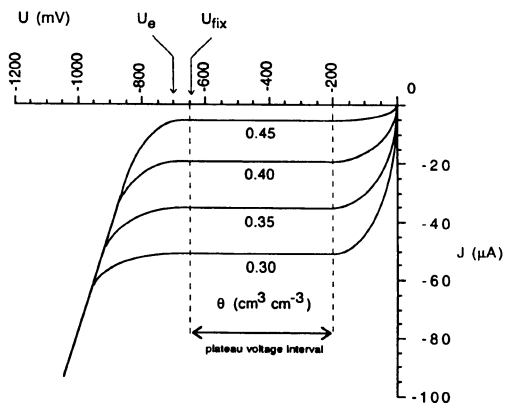

Fig. 2. An idealized chronovoltammetric curve of molecular oxygen reduction.  $U_e$  is potential of electrolysis of the soil water and  $U_{fix}$  is the Pt polarizing potential commonly fixed at the level of -650 mV. The characteristic plateau of the  $J(U)$  relation indicates that within that region of potentials the electrical field developed in the system does not influence the rate of the oxygen reduction, whereas the soil moisture, thus also diffusivity, affects the reduction current predominately.

application. The most important ones are as follows:

- $J$  markedly depends on  $U$  at its full range at any moisture of the soil, thus, the  $J(U)$  plateau seldom, if ever, appears clearly [5]. For this reason care has to be taken to keep the cathode polarizing potential at a constant level,  $U_{fix}$ . So far the  $U_{fix}$  has not been unified yet and happens to be arbitrarily set by different authors within an interval of  $-0.800 \div -0.480$  V [2];
- in most cases the setting of  $U_{fix}$  at a chosen level provides polarization of the cathode at the level greater than the chosen one, especially at the water content less than that of saturation. It is so because the sum of the voltage drops across the soil and the microammeter becomes significant [5, 12];
- the potential of electrolysis of water,  $U_e$ , may happen to be close or much the same as  $U_{fix}$ , dependent on acidity of the soil [2, 13];
- oxygen reduces at active sites of the Pt|solution (soil water) interface, i.e., at these sites of the cathode surface which are covered by water (no reduction occurs at the dry cathode). This limits the application of the Lemon and Erickson's method to saturated or nearly-saturated conditions exclusively, because only then the cathode is covered by a film of water to the maximum extent and its active surface can be determined.

### Premises and hypothesis

#### Premises

Because, in practical terms, current  $J$  ( $-0.65 < U < 0$  V) relates to the electrode process of the oxygen reduction only, it seems justified to expect that  $ODR$  is in direct proportion to the work executed by the electrical current on reduction of the molecular oxygen over a period of time necessary to increase potential of the cathode linearly from  $-0.65$  V to  $0$  V:

$$ODR \sim \int_{-0.65}^0 J dU. \quad (2)$$

In order to discern  $ODR$  calculated according to (1) from that calculated according

to (2) let us introduce a variable named  $OFD$  (oxygen flux density). Both  $OFD$  and  $ODR$  bear the same physical meaning. They are calculated in different way only.

#### Hypothesis

The above conjecture implies that integrating the current-voltage curve over the oxygen reduction potential interval, then dividing the result by the duration time of the oxygen reduction electrode process, should result in numbers related to the amperometric  $ODR$  data calculated from  $J(U_{fix} = -650$  mV) accordingly to the method of Lemon and Erickson. Thus:

- the  $OFD$  and  $ODR$  should be functions of the soil oxygen diffusivity of the same type and  $OFD$  could be used instead of  $ODR$ ;
- $OFD$ , as calculated from the  $J(U)$  data averaged over the potential range in which the oxygen reduction dominates, should provide more accurate data than these from a single calculation of  $ODR$ .

### MATERIALS AND METHODS

Current-voltage curves were recorded for soil samples with different oxygen diffusivity values. Oxygen diffusivity of the investigated soil was altered by changing the sample water content (as the coefficient of oxygen diffusion for water is about 10000 times less than that of air).

#### Materials tested

Samples of 3 soil materials, thereafter referred to as silt, clay and peat, were investigated. Their characteristics are listed in Table 1.

#### Recording oxygen reduction current-voltage curves

Current-voltage curves,  $J(U)$ , were recorded using a chronovoltammeter specially designed for this purpose. The chronovoltammeter consisted of a PC controlling unit followed by a 3-electrode voltammeter [12]. The chronovoltammeter allowed to choose potential setting of the indicator electrode, for as long as needed, independent of parasite voltage sources and voltage drops over constituents of

Table 1. Soil materials studied

Site	Soil type (FAO)	Horizon	Depth (m)	$\rho$ ( $\text{Mg m}^{-3}$ )	$\rho_s$ ( $\text{Mg m}^{-3}$ )	psd ( $\text{kg kg}^{-1}$ )			Organic C ( $\text{kg kg}^{-1}$ )
						clay <0.02 mm	silt 0.02 -0.1 mm	sand 0.1-1 mm	
Czesławice	Orthic Luvisol	Ck	1.4-1.6	1.45	2.48	0.32	0.68	0.00	0.0034
Zarzecze	Eutric Cambisol	Bh	0.2-0.3	1.32	2.43	0.68	0.31	0.01	0.0035
Sosnowica	Terric Histosol	M <sub>1</sub>	0.1-0.3	0.39	1.72				0.8000

$\rho$  - bulk density,  $\rho_s$  - particle density, psd - particle size distribution.

the oxygen reduction current circuit. This allowed application of any conducting material as the current circuit complementing electrode, and a regular small-size SCE as the reference.

The principle of operation of the 3-electrode chronovoltammeter used is illustrated in Fig. 3.

The measuring system consists of two electric circuits: a current circuit that serves for the measurements of the electrical current due to electrode processes at the indicator Pt electrode and a voltage circuit, controlling the electrode potential. Both circuits are closed by the soil.

The current circuit consists of an adjustable ( $\pm 2000$  mV) constant voltage source, a complementary electrode, the soil, an indicator electrode and a microammeter.

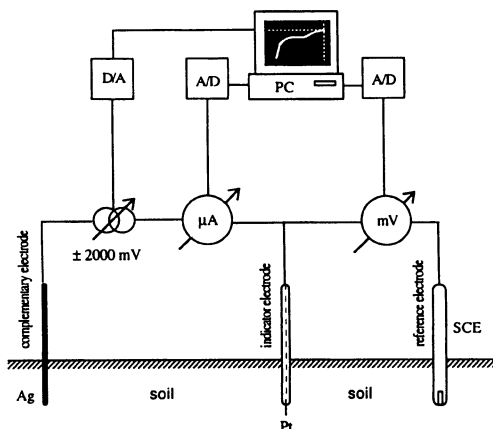

Fig. 3. Principle of the computer-controlled 3-electrode chronovoltammeter used. The negative feedback contributed by the computer as well as by the digital-to-analog converter (DA) and analog-to-digital converters (AD), made the computer possible to control action of the set-up and to record the  $U$ ,  $J(U)$  data. Any metal rod could be used as the complementary electrode and a standard small-size SCE could be applied as the reference.

The voltage circuit consists of a regular small-size reference electrode, the soil, the indicator electrode and a millivoltmeter. The applied electrodes were:

- the reference: a regular small-size saturated calomel electrode, SCE,
- the indicator electrode: a 10 mm long 0.5 mm diameter platinum rod,
- the complementary electrode: 20 mm long 1.5 mm diameter silver rod (the reason to use silver was its insignificant polarizability which allowed application of relatively low voltage to the electrodes|soil system).

Negative feedback contributed by the computer as well as by the digital-to-analog converter (DA) and by analog-to-digital converters (AD), allowed the computer to control action of the set and to record the  $U$ ,  $J(U)$  data.

The chronovoltammeter drove the Pt indicator electrode with alternating voltage wave of potential at random altered within the range of  $-1500$  to  $+1500$  mV, with  $4$  mV  $\text{s}^{-1}$  step (that speed was found sufficiently low to allow reproduction of the electrochemical equilibrium of the system after each subsequent 4 mV potential change).

### Experimental procedure

Samples were air dried and those of mineral materials were sieved through a 1 mm sieve. The samples were moistened with demineralized, aerated water, in six steps to cover the range of moisture from air dryness up to saturation. Each sample was then packed into a beaker (6 cm diameter, 8 cm height) as uniformly as possible, in small increments, up to full volume.

The beakers with the samples were covered with 0.05 mm polyethylene wrap in order to protect them against evaporation then left overnight in the ambient temperature of  $20 \pm 2$  °C to equilibrate.

Electrodes were installed to constitute the array of: anode (Ag), cathode (Pt), reference (SCE) as shown in Fig. 4. Depth of installation was 4 cm.

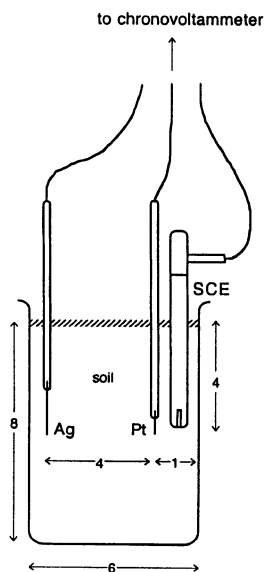

Fig. 4. Principle of installation of the electrodes. The electrodes constitute an array consisting of: the anode (Ag), the cathode (Pt) and the reference (SCE). The SCE is situated possibly close to the cathode Pt rod in order to minimize contribution of potential drop across the soil due to the electrical field developed in the system.

According to Lemon and Erickson [10] the cathode surface has to be free of products of preceding electrode processes in order to keep its status reproducible. This is commonly done by mechanical cleaning of the cathode surface or etching it in a concentrated nitric acid. In case of automated datalogging systems such a pretreatment is impractical because the indicator electrode once installed cannot be reinstalled before each consecutive record.

Therefore, in the experiment discussed here, before recording a current-voltage curve, the cathode surface was pretreated electrically

with potential alternated according to an arbitrarily chosen pattern (the idea behind that was that initial properties of the cathode surface became meaningless after several cycles of the potential wave applied).

The polarizing potential alternated as follows (see Fig. 5):

- linear decrease from 0 down to -1500 mV with the speed of  $4 \text{ mV s}^{-1}$ ,
- instant return to 0,
- 15 min pause,
- linear increase from 0 up to +1500 mV with the speed of  $4 \text{ mV s}^{-1}$ ,
- instant return to 0,
- 15 min pause.

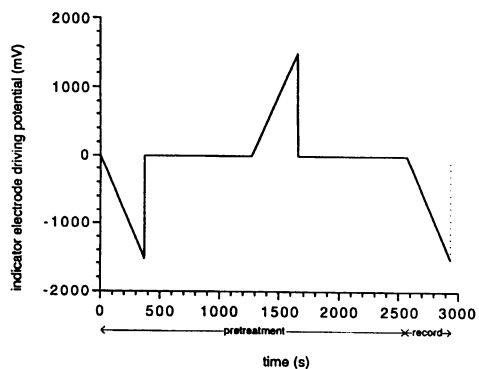

Fig. 5. Alternation of the applied Pt indicator electrode driving potential. Records of a given chronovoltammetric curve were threefold repeated for each but first  $4 \text{ mV s}^{-1}$  potential decrease.

After the pretreatment as above the chronovoltammetric curve was recorded with the Pt indicator electrode polarizing potential linearly and decreasing from 0 down to -1500 mV with the speed of  $4 \text{ mV s}^{-1}$ . The record was then repeated for each subsequent potential decrease. This way each recorded curve was composed of not less than 3 replicates.

Having the oxygen reduction-related current-voltage curve recorded the sample gravimetric water content and bulk density were measured. Also particle density was determined using the standard pycnometric method. Then the whole procedure was repeated for another sample.

RESULTS AND DISCUSSION

The current-voltage curves are shown in Fig. 6. It can be observed that within the range of the cathode polarizing potential  $-650 \div 0$  mV electrical current is distinctly affected by the water content, thus also by the ODR. The lack of the  $J(U)$  plateau as well as the appear-

ance of a weak quasiplateau can be noticed for near saturation and saturation water contents respectively.

If potential of the cathode increases linearly then velocity,  $v$ , of the potential increase can be expressed as:

$$v = \frac{\Delta U}{\Delta t} \tag{3}$$

Accounting for  $\Delta t = t_2 - t_1$  and putting  $t_1 = 0$  leads to:  $\Delta t = t_2 = t$ .

Thus, duration,  $t$ , of the cathode polarization can be expressed as:

$$t = \frac{\Delta U}{v} \tag{4}$$

Gram-equivalent,  $k$ , is defined as:

$$k = \frac{M_o}{nF} \tag{5}$$

Let's introduce:

$$i = J(U_{fix}) \tag{6}$$

and:

$$J = J(U(t)) \tag{7}$$

Based on the above the following expressions can be derived for ODR and OFD, respectively:

$$ODR = \frac{m}{St} = \frac{kit}{St} = \frac{M_o}{nFS} i = ai = aJ(U_{fix}) \tag{8}$$

$$OFD = \frac{m}{St} = \frac{kJt}{St} = \frac{kQ}{St} = \frac{M_o}{nFS} \int_{t_1=0}^{t_2=t} Jdt =$$

$$\frac{a}{t} \int_0^1 Jdt = \frac{a}{\Delta U} \int_{U_1=-0.65V}^{U_2=0V} JdU \tag{9}$$

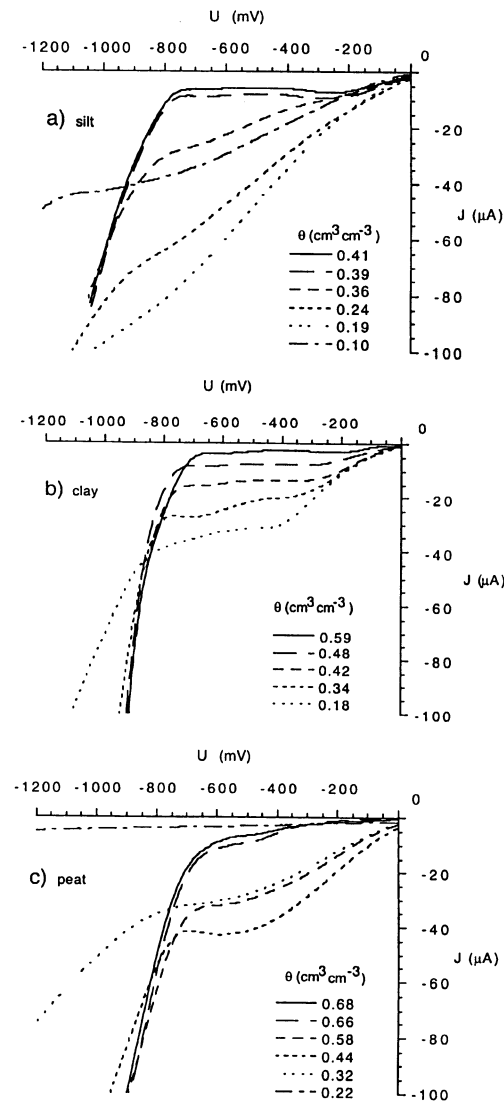

Fig. 6. The current-voltage curves obtained for the investigated samples of a) silt, b) clay and c) peat. It can be observed that within the range of the cathode polarizing potential  $0 \div -650$  mV electrical current is distinctly affected by water content, thus also by ODR. The current-voltage curves lack the quasiplateau at water contents less than saturation.

There is a certain, soil specific, threshold moisture,  $\theta_p$ , below which the film of water covering the Pt cathode loses continuity and the method fails. Figure 7 illustrates relations of ODR, as well as OFD, versus water content,  $\theta$ , for the investigated soils, with the  $\theta_t$  marked. For the upper range of water contents, where  $\theta > \theta_t$ , ODR is reported to be in reverse proportion to the soil moisture [4,8]. A line was fitted to each  $ODR(\theta)$  and also  $OFD(\theta)$  relation for  $\theta > \theta_p$ . It can be noticed that for the

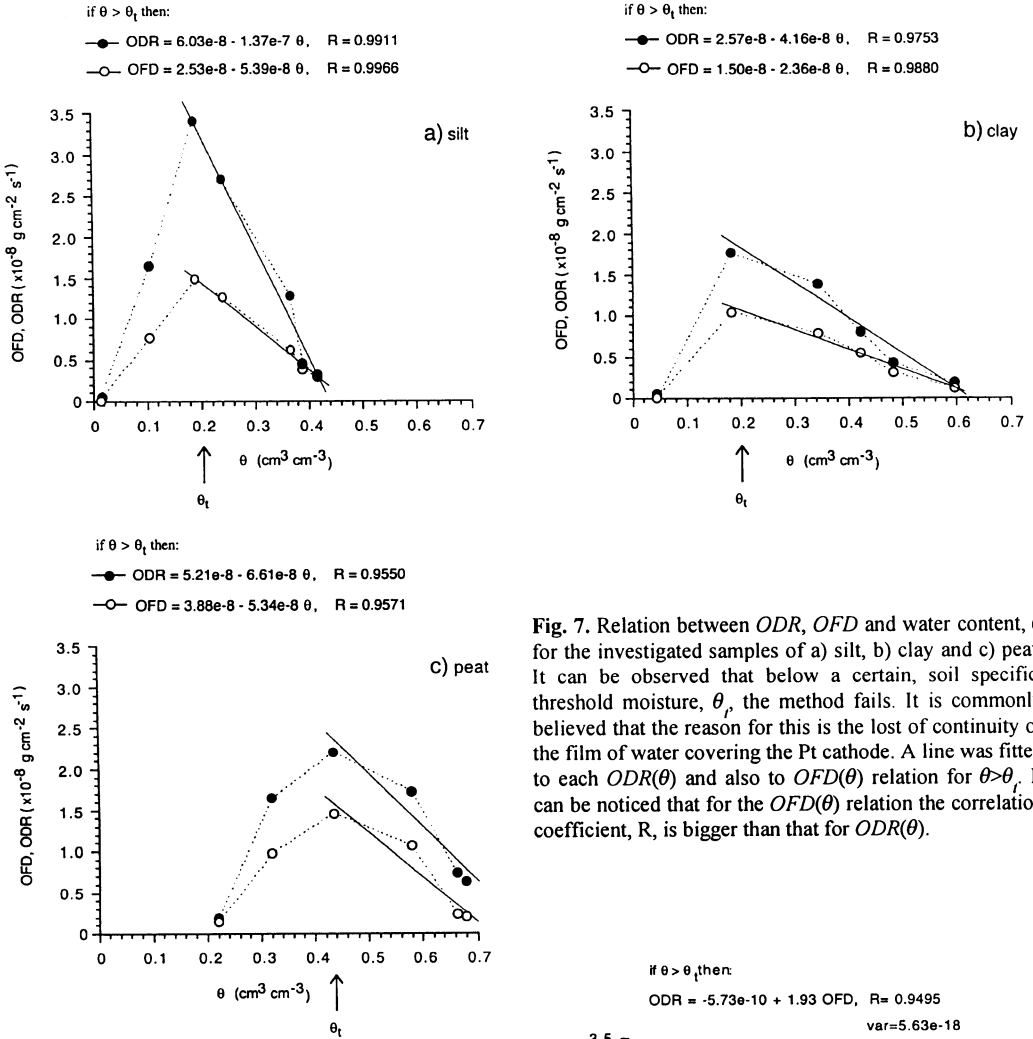

Fig. 7. Relation between *ODR*, *OFD* and water content,  $\theta$  for the investigated samples of a) silt, b) clay and c) peat. It can be observed that below a certain, soil specific, threshold moisture,  $\theta_t$ , the method fails. It is commonly believed that the reason for this is the lost of continuity of the film of water covering the Pt cathode. A line was fitted to each *ODR*( $\theta$ ) and also to *OFD*( $\theta$ ) relation for  $\theta > \theta_t$ . It can be noticed that for the *OFD*( $\theta$ ) relation the correlation coefficient, *R*, is bigger than that for *ODR*( $\theta$ ).

*OFD*( $\theta$ ) relation the correlation coefficient, *R*, is higher than that for *ODR*( $\theta$ ), thus *OFD* seems to be a more accurate measure of the oxygen diffusion in the soil than *ODR* is.

Figure 8 illustrates *ODR* versus *OFD* for the all soils as calculated for the  $\theta > \theta_t$  water content range. Fair linearity of the relation as well as the consistency of the *ODR* and *OFD* data seem to justify the thesis that *J*(*OFD*) and *i*(*ODR*) are functions of the same type.

CONCLUSIONS

- *J*(*OFD*) and *i*(*ODR*) are functions of the same type.

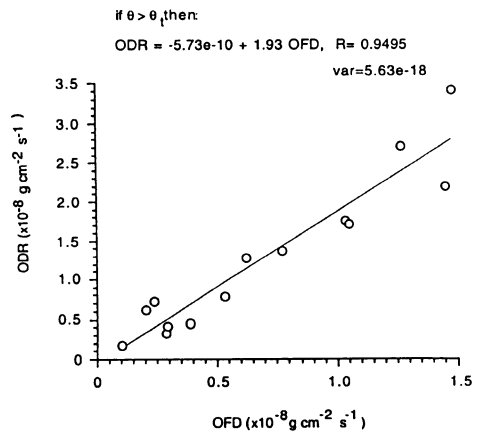

Fig. 8. Relation between *ODR* and *OFD* obtained for the investigated soils having water contents  $\theta > \theta_t$ . Fair linearity of the relation as well as the consistency of the *ODR* and *OFD* data show that the reduction currents *OFD* and *ODR* are similar functions of the soil oxygen diffusivity.



- Calculating *OFD* from the mean value of the oxygen reduction current over the range of cathode potentials within which the oxygen reduction dominates, results in numbers related to the amperometric *ODR* data obtained using the method of Lemon and Erickson.
- *OFD* is a more accurate measure of the diffusive flux of oxygen in the soil than *ODR* is, thus *OFD* can be used instead of *ODR*.
- Recording a chronovoltammetric curve over the range of cathode potentials within that oxygen reduction dominates, makes the problem of magnitude of the cathode polarizing potential immaterial.

## REFERENCES

1. **Bard A.J.:** Encyclopedia of electrochemistry of the elements. Marcell Dekker, Inc., II, 210-238, 1974.
2. **Bieganowski A.:** Determination of the soil oxygen microdiffusion as based on current-voltage curve of its reduction (in Polish). Doctor Thesis, Polish Academy of Sciences, Institute of Agrophysics, Lublin, Poland, 1997.
3. **Conway B.E.:** Theory and principles of electrode processes. The Ronald Press Comp., New York, 183-183, 1965.
4. **Gawlik J.:** Influence of soil moisture and aeration on oxygen microdiffusion (*ODR*) for some hydrogenic and podsolc soils (in Polish). Roczniki Nauk Rolniczych, F, 79, 1, 95-116, 1975.
5. **Gawlik J., Malicki M., Stępniewski W.:** The problem of effective voltage control in measurement of *ODR* in soil. Polish J. Soil Sci., X, 1, 9-14, 1977.
6. **Gliński J., Stępniewski W.:** Soil Aeration and Its Role for Plants. CRC Press, Inc., 1985.
7. **Gliński J., Stępniewska Z., Stępniewski W., Ostrowski J.:** Importance of soil oxygenation conditions in reclamation projects (in Polish). Problemy Agrofizyki, 67, 65-84, 1992.
8. **Kowalik P.:** Ground physics outline (in Polish). Gdańsk Institute of Technology Publishers, 51-52, 1973.
9. **Lemon E.R., Erickson A.E.:** The measurement of oxygen diffusion in the soil with a platinum microelectrode. Soil Sci. Soc. Am. Proc., 16, 160-163, 1952.
10. **Lemon E.R., Erickson A.E.:** Principle of the platinum microelectrode as a method of characterizing soil aeration. Soil Sci., 79, 383-392, 1955.
11. **Malicki M.:** Measurements of redox potential and Oxygen Diffusion Rate (*ODR*) in the soils. Zesz. Probl. Post. Nauk Roln., 388, 115-127, 1990.
12. **Malicki M., Walczak R.:** A gauge of the redox potential and the Oxygen Diffusion Rate in the soil with an automatic regulation of cathode potential. Zesz. Probl. Post. Nauk Roln., 220, 447-451, 1983.
13. **McIntyre D.S.:** The platinum microelectrode method for soil aeration measurement. Advances in Agronomy, 22, 235-283, 1970.