

PREDICTION OF APPLE BRUISING BASED ON THE INSTANTANEOUS IMPACT SHEAR STRESS AND ENERGY ABSORBED

*Y. Yuwana*¹, *F. Duprat*²

¹ Faculty of Agriculture, Bengkulu University, Jln. Raya Kandang Limun, Bengkulu, Indonesia

² INRA, Laboratoire de Méthodes Physiques d'Etude, Site Agroparc, Domaine Saint Paul, F 84914 Avignon Cedex 9 France (Author's present address)

Accepted February 26, 1997

A b s t r a c t. Instantaneous impact shear stress together with the instantaneous energy absorbed were used to predict bruise volume in Golden Delicious apple. The prediction produced a linear relation between the predicted bruise volumes and the measured bruise volumes with a factor of proportionality (K) 1.08 and a coefficient of correlation (R) 0.949. Both the instantaneous impact shear stress and energy absorbed decreased during storage of the fruit, but the value of K was relatively constant. The value of K was also relatively constant for the impact with small drop heights, but it slightly increased with the variation of fruit mass.

K e y w o r d s: apple, instantaneous impact shear stress, instantaneous energy absorbed, predicted bruise volume, measured bruise volume.

INTRODUCTION

Beginning from handling on the farm, through various stages of distribution and processing, until eating, apples are subjected to various loading conditions which lead to mechanical failure. One of the common modes of failure is bruising. Between 20-50 % of apples are bruised during handling [15].

Many theories have been explored for agricultural products [4,7,11,20-23,28] and most researchers [7,14,15,17,22,27,28] believe that failure is due to shear stress.

Bruising begins when the shear stress reaches a certain value. Because of this the critical shear stress may be defined as the current bruising strength [15]. For any material there will be limits to the normal and shear

stresses it can withstand which correspond to bruising strengths. Shear failure is dependent on the maximum difference in normal stresses and independent of the absolute value of the normal stresses. Within the diagram of solid materials, for a rising load, as the stresses on the material increase, the mode of failure will be determined by the strength boundary first encountered [34]. If the size of the Mohr's circles increases, due to increasing differences in stress, and reaches first a boundary on the shear stress, bruising occurs [14].

In the case of compression tests, failure can be detected from the deflection (yield) points in the force-deformation curve. This point has been used to assess bruising [1,18,24,26]. In impact this sort of deflection is not always visible. One usually utilises other impact parameters and relates them to bruising. Maximum force [5], maximum deformation [5,6], approach energy [2], energy absorbed [2,3,6,13,14,16,26,29,30], coefficient of restitution [8], maximum acceleration [6,32,33,34], velocity change [32,33], maximum value of the time rate of change of acceleration and impact time [6] have been used to predict bruising.

In the previous work [36], employing Hertz' theory, we used the modulus of elasticity together with the mass of fruit, and drop

height, to predict bruise volume in apple. Because it is evident that failure is caused mainly by shear, in the present work we tried to utilise the instantaneous impact shear stress together with energy absorbed to predict bruise volume.

THEORY

Impact assessment

If an apple is considered as a sphere, assuming that i) all the mass was subjected to the same acceleration, ii) the centre of the sphere and the centre of mass remained coincident during contact and iii) the internal vibrations could be neglected; the motion of the centre of the mass of the sphere can be quantified as follows [10,19]:

- acceleration (γ , ms^{-2}):

$$\gamma = g - \frac{F}{M} \tag{1}$$

- velocity (v , ms^{-1}):

$$v = v_o - \int_0^t \gamma dt \tag{2}$$

- neglecting air friction, velocity of fruit at the beginning of contact v_o (ms^{-1}) can be calculated from the drop height as:

$$v_o = \sqrt{2gh}$$

- displacement (x):

$$x = \int_0^t v dt \tag{3}$$

where F - force measured by the transducer (N), M - mass of fruit (kg), g - gravity constant (9.81 ms^{-2}), t - time after the first contact (s) and h - drop height (m).

Figure 1 shows schematic curves of impact characteristics showing acceleration, velocity and contact area as a time function. The curve of the contact area-time function was established assuming an apple is a sphere. The instantaneous impact (normal) force is determined as follows: instantaneous contact area value is reported on the theoretical curve of contact area variations in order to determine corresponding instantaneous acceleration at time t . The instantaneous impact force is then

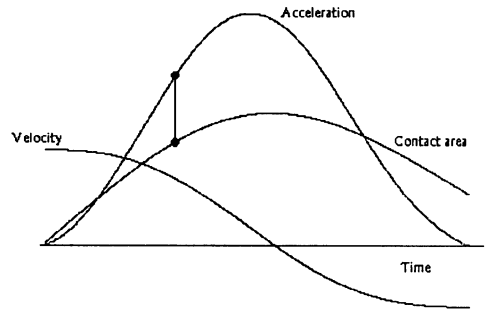

Fig. 1. Curves of impact characteristics showing acceleration, velocity and contact area versus time of contact. Example given for: apple mass: 0.086 kg, maximum acceleration 63.1 G, initial velocity 0.77 ms^{-1} , final velocity -0.53 ms^{-1} , maximum contact area $1.79 \cdot 10^{-6} \text{ m}^2$, non recoverable area $0.68 \cdot 10^{-6} \text{ m}^2$, contact duration $4.09 \cdot 10^{-3} \text{ s}$. Filled circles indicate measured contact area ($1.39 \cdot 10^{-6} \text{ m}^2$) and its corresponding instantaneous acceleration.

calculated by multiplying this instantaneous acceleration by fruit mass. The instantaneous normal stress can then be expressed as:

$$\sigma_t = \frac{F_t}{S_t} \tag{4}$$

where σ_t - instantaneous normal stress (Pa), F_t - instantaneous force (N), and S_t - instantaneous contact area (m^2).

The contact area forms an ellipse so S_t can be calculated from:

$$S_t = \pi AB \tag{5}$$

where S_t - instantaneous contact area (m^2), A - major ellipse radius (m), and B - minor ellipse radius (m).

The instantaneous shear stress is calculated from the relation given by Shigley [17, 25,31]:

$$\tau_t = 0.27\sigma_t \tag{6}$$

where τ = instantaneous shear stress (Pa).

Up to the point of t (a point where the contact area equals to S_t), the fruit is still in compression so the energy absorbed is:

$$E_t = \frac{1}{2} M(v_o^2 - v_t^2) \tag{7}$$

where E_t - energy absorbed up to the time of t (J), v_t - instantaneous velocity (ms^{-1}).

Bruise prediction

Within dynamic impact metal testing, the volume of the remaining indentation can be assessed by dividing the energy absorbed with the dynamic yield stress [35]. If we use this analogy and we can introduce the shear stress, and the energy absorbed, to predict the bruise volume, and write our predicting equation as follows:

$$V = \frac{E_t}{\tau_t} \quad (8)$$

where V - bruise volume (m^3).

In the first experiment, fruit from the same category, having about the same size, were used for testing. For every test a sample of 20 apples was used. The first test was conducted five days after harvest and then every month a sample with the same size was randomly taken from storage for the next test. The fruit were followed for five months storage time. Before testing the fruit were exposed to an ambient temperature of 20 °C for 24 h. The fruit were weighted and their densities were determined by weighing them in the water. Physical data of fruit used in the first experiment are presented in Table 1. Every

Table 1. Main characteristics of the soil in the wheat field

Horizon	Depth (cm)	pH (%)	CaCO ₃ (%)	EC (mS/cm)	Salt (%)	OM (%)	Bd (g/cm ³)
A11	0-30	8.1	9.1	0.53	0.035	3.8	1.35
A12	30-35	8.1	9.1	0.53	0.035	3.8	1.40
AC	35-70	8.3	25.8	0.58	0.040	1.2	1.34
C	70-..	8.4	28.4	0.61	0.040	0.7	1.39

It should be noted that in Tabor's equation the maximum shear stress and the energy absorbed after the impact are used assuming that not all energy absorbed could be spent for plastic deformation. Here we tried to use the total energy absorbed up to time t , where t is the time when the instantaneous contact area equals the measured contact area.

MATERIAL AND METHODS

Golden Delicious apples grown in the experimental orchard, INRA Avignon, France were used in the experiments. The fruit were manually harvested and then stored at 2 °C and 95 % humidity, until they were needed for experiment. Three experiments were set up.

fruit was dropped from 0.05, 0.15, 0.25 and 0.35 m on its different equatorial parts.

In the second experiment, 80 apples were used. Here the fruit had been stored just one week. The fruit were randomly separated into four groups designated for four different drop heights. The drop height consisted of 0.015, 0.020, 0.035 and 0.050 m.

The third experiment employed 20 fruits having a very large variation in mass considering all possible apple sizes for this variety. The fruit had been stored two weeks. In this case every fruit was dropped from 0.03, 0.06, 0.10 and 0.15 m.

Physical data for the second and the third experiments are given in Table 2.

Table 2. Particle-size distribution of the soil in the wheat field

Horizon	Depth (cm)	(mm)						
		>25	0.05-0.25	0.02-0.05	0.01-0.02	0.005-0.01	0.002-0.005	<0.002
A11	0-30	1.9	10.7	32.9	13.7	7.0	8.7	25.1
A12	30-35	1.9	10.7	32.9	13.7	7.0	8.7	25.1
AC	35-70	0.5	10.0	32.7	11.0	7.1	8.2	30.5
C	70-...	0.4	10.7	36.5	13.1	6.7	7.5	25.1

Impact Test

Figure 2 illustrates the impact instrumentation used in the experiment. This mainly consists of a concrete block impact base equipped with an impact support, a force transducer type 9321A, an amplifier type 2626 Bruel and Kjaer and a 12 bits digital oscilloscope Nicolet type 310 connected to an IBM computer via an interface card IEEE-488. The impact support consisted of a stand, an aluminium plate impact surface with the transducer installed below, a vacuum pump, and a sliding metal bar mounted on the stand.

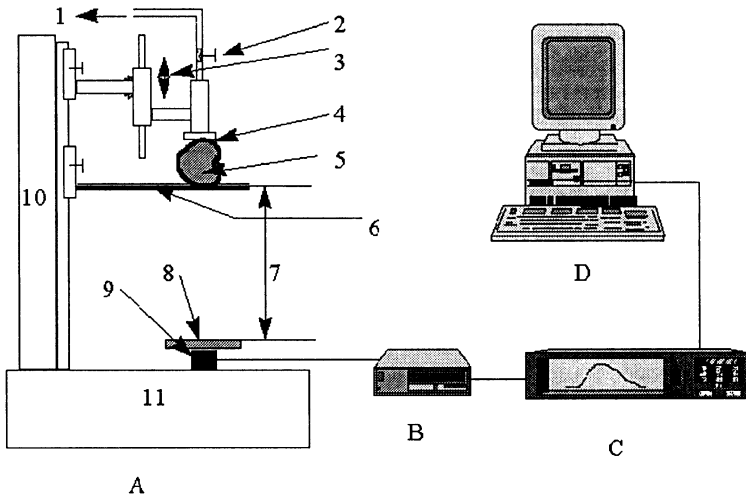

Fig. 2. Impact instrumentation showing: A - Impact device with 1) rubber pipe of the vacuum pump, 2) valve, 3) adjustable drop height to fruit diameter, 4) rubber ring 5) apple, 6) sliding metal bar adjustable to drop height, 7) drop height, 8) aluminium plate, 9) transducer, 10) stand 11) concrete block; B - Amplifier; C - Oscilloscope, and D - Computer.

During operation the fruit was held by the vacuum pump and the drop height was fixed by the metal bar and the adjusting fruit position. The fruit was then released, without initial speed, to strike against the impact surface on its cheek. The fruit was caught by hand just after striking to avoid second impact. The impact signal captured in the form of an electrostatic charge was then transformed in voltage by the amplifier. This voltage was then transmitted to the digital oscilloscope with a rate of $2 \mu\text{s}$ per point and displayed in the form of spectre in time function. This impact spectre was finally stored in the computer for further analysis.

Bruise measurement

For marking the contact area, the impact surface was smeared with blue inks made of oil and colour powder. The minor and major diameters were measured. The bruise was sectioned through its centre 24 h after impact to measure its diameter and depth. To observe the bruise zone, the bruise section was immersed in 'safranin-O' solution for 3 s. The measurement was made a few minutes after immersion to obtain the best contrast between the zone of bruised tissues and the zone of intact tissues.

Figure 3 shows a typical cross-section of

the bruise showing parameters used in the calculation while Fig. 4 shows various aspects of bruising zones. The bruise above the contact plane is equivalent to the volume of a spherical segment and can be calculated from:

$$V_1 = \frac{\pi}{3} h^2 (3R - h) \quad (9)$$

where h - the depth of crushed zone (m), $h = R - (R^2 - a^2)^{1/2}$, a - bruise radius (m) and R - apple radius (m).

The radius of this sphere (apple) can be approximated by:

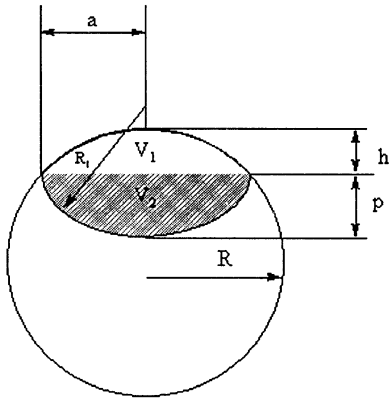

Fig. 3. Bruise section showing parameters used in bruise volume calculation.

$$V_2 = \frac{\pi}{6} p(3a^2 + p^2) \tag{11}$$

where p - bruise depth (m) and R_1 - radius of the bruising zone (m), $R_1 = \frac{a^2 + p^2}{2p}$.

Thus, the total bruise volume, V is the total volume of V_1 and V_2 .

Data for the first experiment were first analysed globally to see the general response and then analysed separately for every test to evaluate the change of the response respecting the evolution of the fruit during storage. Data for the second and the third experiments were used to observe the impact of low energy and the effect of fruit mass, respectively.

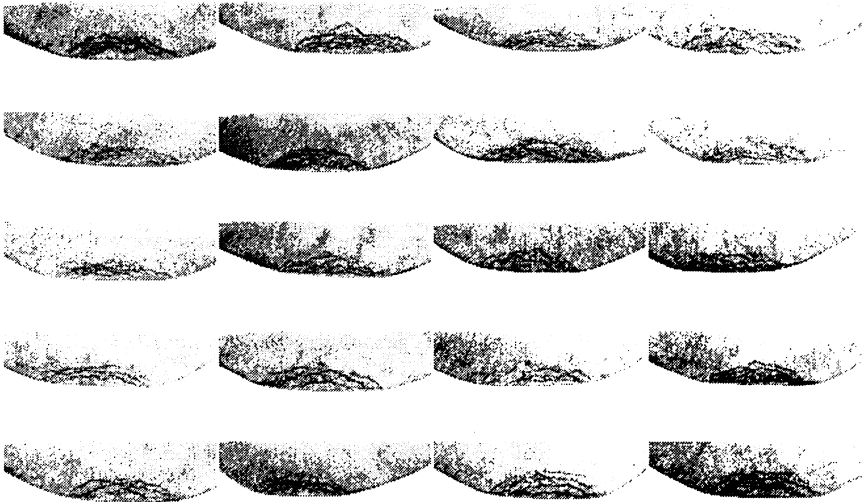

Fig. 4. Various aspects of bruising zone.

$$R = \left(\frac{3M}{4\pi\rho} \right)^{\frac{1}{3}} \tag{10}$$

where M - apple mass (kg) and ρ - apple density (kg m^{-3}).

Similarly, the volume of bruise below the contact plane is given by:

$$V_2 = \frac{\pi}{3} p^2 (3R_1 - p)$$

or

RESULTS AND DISCUSSION

Observation on bruising revealed that the cells ruptured group by group commencing from the group having the weakest cell strength, which was not necessarizing the cells nearest the skin. This was proved by the fact that the majority of bruises produced by the impact with a small drop height formed lines of cell ruptures at certain depths, which were not always aligned horizontally, while the cells near the skin rested intact. This kind of situation might demonstrate the heterogeneity of fruit [9]. The bruise diameter was smaller

than the contact diameter. The smaller the drop height the bigger the difference between the bruise diameter and the contact diameter. For all the fruit tested the bruise diameter was on average 6.44 % smaller than its corresponding contact diameter. Based on this evidence, the bruise contact area changed little after the first groups of cell had ruptured. So using the measured contact area to estimate the normal stress should not cause significant errors in bruise prediction.

Figure 5 shows the measured bruise volumes plotted against the predicted bruise volumes using the data from the first experi-

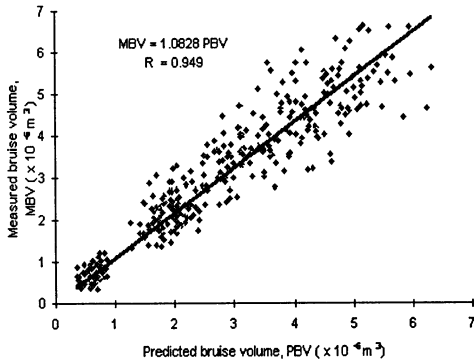

Fig. 5. Measured bruise volume plotted against predicted bruise volume for the first experiment.

ments. The predicted bruise volumes linearly correlate to the measured bruise volume with a factor of proportionality (K) 1.08 and a coefficient of correlation (R) 0.949. It could be said that, in general, the prediction gave 8 % error. Comparing to the original Tabor's equation it can be noted that in the case of bio-materials (apple) most total energy absorbed was used for plastic deformation (bruising).

To see the changes in shear stress, energy absorbed, and the relation between the predicted bruise volumes and the measured bruise volumes during storage, data were analysed for every test in the experiment. Figures 6 and 7

Table 3. Main characteristics of the soil in the maize field

Horizon	Depth (cm)	pH (%)	CaCO ₃ (%)	EC (mS/cm)	Salt (%)	OM (%)	Bd (g/cm ³)
Ap	0-20	8.1	2.0	0.71	0.05	3.8	1.34
A	20-44	8.2	5.3	0.49	0.03	3.1	1.36
AC	44-75	8.3	22.8	0.47	0.03	2.0	1.39
C	75-..	8.3	31.2	0.54	0.03	0.5	1.40

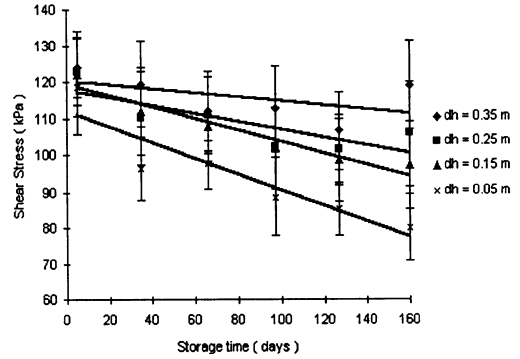

Fig. 6. Shear stress plotted against storage time (grouped according to drop height).

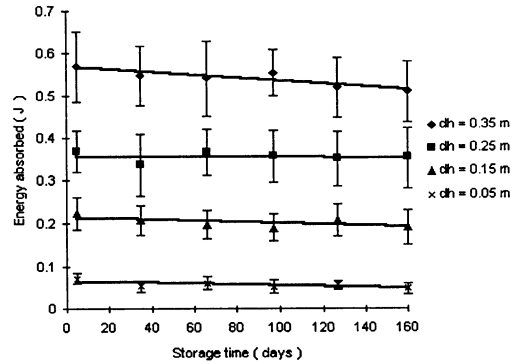

Fig. 7. Energy absorbed plotted against storage time (grouped according to drop height).

present respectively the changes in shear stress and energy absorbed during storage. Generally both the shear stress and energy absorbed decreased during storage. Table 3 gives the relationships between the predicted bruise volumes and the measured bruise volumes for each test of the first experiment.

From Table 3, it can be seen that the value of K is relatively constant during the storage period, although the shear stress and the energy absorbed decreased. This is different to the result

In practice, a group of fruit may be subjected to impact independently from the other groups and may experience small drop heights.

The second experiment was used to explore this kind of situation. Figure 8 shows the rela-

CONCLUSION

The bruise prediction based on the instantaneous impact shear stress and the instantaneous energy absorbed produced a linear relation between the predicted bruise volumes and the measured bruise volumes with a factor of proportionality (K) 1.08 and a coefficient of correlation (R) 0.949. Both the instantaneous impact shear stress, and energy absorbed, decreased during the storage period of the fruit, but the value of K was relatively constant. Impact with small drop heights also produced a linear relation between the predicted bruise volumes and the measured bruise volumes with a K value of 1.163 and a R value of 0.909. With the variation of fruit mass, including all possible commercial fruit size for this apple variety, the linear relation between the predicted bruise volumes and the measured bruise volumes had a K value of 1.346 and a R value of 0.910.

REFERENCES

1. **Blahovec J., Jeschke J., Houska M., Paprstein F.:** Mechanical properties of sweet and sour cherries and their susceptibility to mechanical damage. *Scientia Agriculturae Bohemica*, 95-107, 1994.
2. **Brusewitz G.H., Bartsch J.A.:** Impact parameters related to post harvest bruising of apples. *Trans. ASAE*, 32(3), 953-957, 1989.
3. **Brusewitz G.H., McCollum T.G., Zhang, X.:** Impact bruise resistance of peaches. *Trans. ASAE*, 34(3), 962-965, 1991.
4. **Chen P., Sun Z.:** Critical strain failure criterion: Pros and cons. *Trans. ASAE*, 27(1), 278-281, 1984.
5. **Chen P., Ruiz M., Lu F., Kader A.A.:** Study of impact and compression damage on Asian pears. *Trans. ASAE*, 30(4), 1193-1197, 1987.
6. **Chen P., Yazdani R.:** Prediction of apple bruising due to impact on different surfaces. *Trans. ASAE*, 34(3), 956-961, 1991.
7. **Diehl K.C., Hamann D.D., Whitfield J.K.:** Structure failure in selected raw fruits and vegetables. *J. Texture Studies*, 10, 371-400, 1979.
8. **Diener R.G., Elliot K.C., Nesselroad P.E., Ingle M., Adams R.E., Blizard S.H.:** Bruise energy of peaches and apples. *Trans. ASAE*, 22(2), 287-290, 1979.
9. **Duprat F., Roudot F., Nicolas M.G., Roudot A.C.:** De l'hétérogénéité des fruits. *Sciences des aliments*, 11, 613-626, 1991.
10. **Fluck R.C., Ahmed E.M.:** Impact testing of fruits and vegetables. *Trans. ASAE*, 16(4), 660-666, 1973.
11. **Gan-Mor S., Galili N.:** Model for failure and plastic flow in dynamic loading of spheres. *Trans. ASAE*

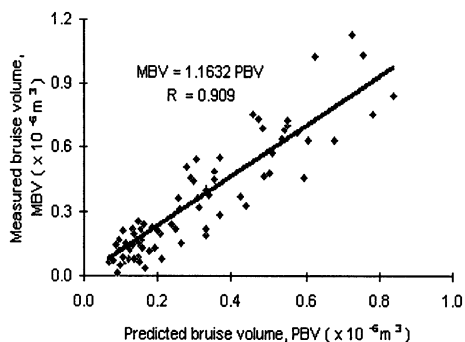

Fig. 8. Measured bruise volume plotted against predicted bruise volume for the second experiment.

tionship between the predicted bruise volumes and the measured bruise volumes. The linear relation produces a factor of proportionality (K) 1.163 and a coefficient of correlation (R) 0.909. Compared to the values of K in the first experiment, this K value is relatively constant. It suggests that the prediction is reliable. But attention should be paid when applying low impact energy to ensure that plastic deformation really occurs during impact.

The third experiment was used to observe the effect of mass variation. The sample included all possible commercial sizes of apples for this variety. The measured bruise volumes plotted against the predicted bruise volumes is shown in Fig. 9. The linear relation produces a K value of 1.346 with R value of 0.910. This suggests that the bruise prediction is influenced by the mass variation.

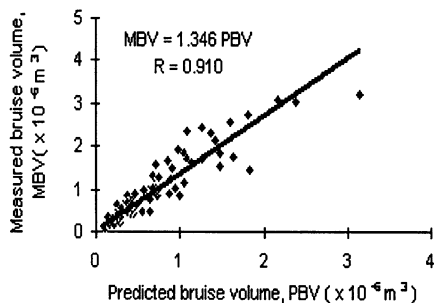

Fig. 9. Measured bruise volume plotted against predicted bruise volume for the third experiment.

- 30(5), 1506-1511, 1987.
12. **Holt J.E., Schoorl D.:** Bruising and energy dissipation in apples. *J Texture Studies*, 7, 427-432, 1977.
 13. **Holt J.E., Schoorl D.:** A theoretical and experimental analysis of the effects of suspension and road profile on bruising in multilayered apple packs. *J. Agric. Eng. Res.*, 31, 397-308, 1985.
 14. **Holt J.E., Schoorl D.:** Mechanics of failure in fruits and vegetables. *J. Texture Studies*, 13, 83-97 1982.
 15. **Holt J.E., Schoorl D.:** The robustness of a model predicting bruising in impacted multilayered packs. *J. Agric. Eng. Res.*, 28, 97-105, 1983.
 16. **Holt J.E., Schoorl D., Lucas C.:** Prediction of bruising in impact multilayered apple packs. *Trans. ASAE*, 24(1), 242-247, 1981.
 17. **Horsfield B.C., Fridley R.B., Claypool L.L.:** Application of theory of elasticity to the design of fruit harvesting and handling equipment for minimum bruising. *Trans. ASAE*, 15, 746-750, 753, 1972.
 18. **Jarimopas B., Manor G., Sarig Y.:** Mechanical behaviour and bruising of apple under quasi-static loading. *ASAE Paper No. 84-1096*, 1984.
 19. **Lichtensteiger M.J., Holmes R.G., Hamdy M.Y., Blaisdell J.L.:** Impact parameters of spherical viscoelastic objects and tomatoes. *Trans. ASAE*, 31(2), 595-602, 1988.
 20. **McLaughlin N.B.:** Statistical models for failure of apple tissue under constant strain rate and loading. *J. Texture Studies*, 18, 173-186, 1987.
 21. **McLaughlin N.B., Pitt R.E.:** Failure characteristics of apple tissue under cyclic loading. *Trans. ASAE*, 27(1), 311-320, 1984.
 22. **Miles J.A., Rehkugler G.E.:** A failure criterion for apple flesh. *Trans. ASAE*, 16(6), 1148-1153, 1973.
 23. **Mohsenin N.N.:** Characterization and failure in solid foods with particular reference to fruits and vegetables. *J. Texture Studies*, 8, 169-193, 1977.
 24. **Mohsenin N.N., Goehlich H., Tukey L.D.:** Mechanical behaviour of apple fruits as related to bruising. *Proc. Ame. Soc. Hortic. Sci.*, 81, 67-77, 1962.
 25. **Mohsenin N., Jindal V.K., Manor A.N.:** Mechanics of impact of a falling fruit on a cushioned surface. *Trans. ASAE*, 21, 594-600, 1978.
 26. **Nelson C.W., Mohsenin N.N.:** Maximum allowable static and dynamic loads and effect of temperature for mechanical injury in apples. *J. Agric. Eng. Res.*, 13(4), 305-317, 1968.
 27. **Peleg M., Gomez Brito L., Malevski Y.:** Compressive failure patterns in some juicy fruits. *J. Food Sci.*, 41, 1320-1324, 1976.
 28. **Pitt R.E.:** Stress-strain failure characteristics of potato tissue under cyclic loading. *J. Texture Studies*, 15, 131-155, 1984.
 29. **Schoorl D., Holt J.E.:** Bruise resistance measurements in apples. *J. Texture Studies*, 11, 389-394, 1980.
 30. **Schoorl D., Holt J.E.:** Impact bruising in 3 apple pack arrangements. *J. Agric. Eng. Res.*, 27, 507-512, 1982.
 31. **Sitkei G.:** *Mechanics of Agricultural Materials*. Elsevier, Amsterdam (NL), *Dev. Agric. Eng.*, 8, 48, 1986.
 32. **Siyami S., Brown G.K., Burgess G.J., Gerrish J.B., Tennes B.R., Burton C.L., Zapp R.H.:** Apple impact bruise prediction models. *Trans. ASAE*, 31(4), 1038-1046, 1988.
 33. **Sober S.S., Zapp H.R., Brown G.K.:** Simulated packing line impacts for apple bruise prediction. *Trans. ASAE*, 33(2), 629-636, 1990.
 34. **Stroshine R., Pitt R.E., Hamann D.:** *Physical properties of agricultural materials and food products*. Stroshine Ed., West Lafayette (USA), 181, 1992.
 35. **Tabor D.:** *The hardness of metals*. Oxford At The Clarendon Press, 175 p, 1951.
 36. **Yuwana Y., Duprat F.:** Postharvest impact bruising of apple as related to the modulus of elasticity. *Int. Agrophysics*, 10, 131-138, 1996.